

Installation Instruction

Product Code: SPOTEMDL1W

Product Description: LED Emergency Downlight



Specification

Emergency Power: 1.2W
 Emergency Lumen: 120lm(Open area lens)
 130lm(Corridor lens)
 EM Duration: 3 hours
 Ambient Temp: 5-45°C
 Emergency Mode: Non-Maintained
 Function: Standard
 Battery: LiFePO4 3.2V 1500mAh
 Guarantee: 3 Years

Routine Testing

Testing should be carried out in accordance with the recommendations of BS5266 & EN50172.

1. Do not switch off unswitched mains supply after installation. If interruption is unavoidable, the batteries must be disconnected or damage to the batteries may occur. Leave the luminaire on continuous charge for 24 hours.
2. A monthly functional test should be conducted manually.
3. Annually, a full three hour duration test should be conducted manually.
4. Batteries should be replaced when the luminaire no longer meets the 3 hours duration performance.
5. Testing is performed by interrupting the unswitched supply for the test duration manually.
 During testing the luminaire should remain illuminated in emergency mode.
6. Ensure that the 'charge indicator' is 'ON' during 'Charging Mode'.
 If the charge indicator (LED) is unlit, this signifies a fault.
7. Replace faulty light source and batteries immediately.
 To assist with this testing, a test record is included below.
 To increase the chance of a fault being reported between monthly tests, it is desirable that staff are made aware of the purpose of the indicator.

Testing Record

Product: _____

Location: _____

Installation Date: _____

Month	Functional/Duration	Year 1	Year 2	Year 3	Year 4	Year 5
1						
2						
3						
4						
5						
6						
7						
8						
9						
10						
11						
12						

Installation Instruction

Dimension

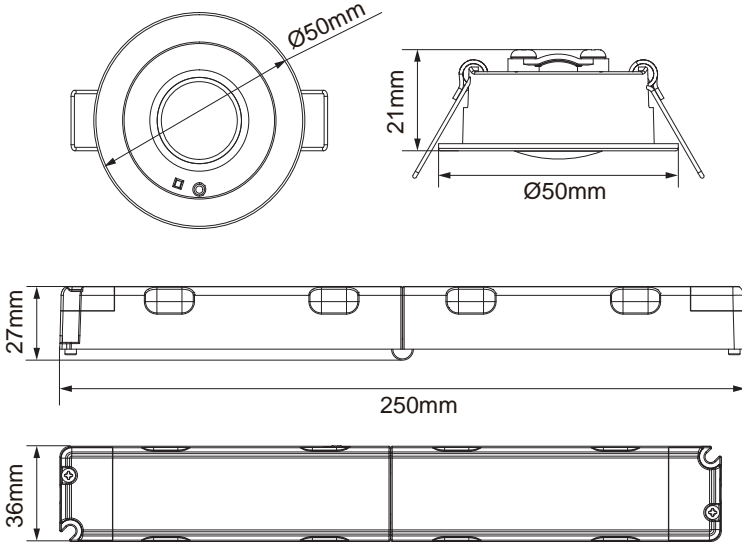

1

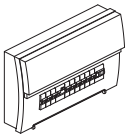

ALWAYS SWITCH OFF THE
MAINS SUPPLY BEFORE
INSTALLATION OR SERVICING

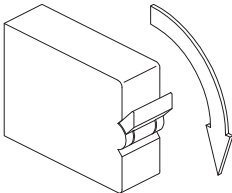

2

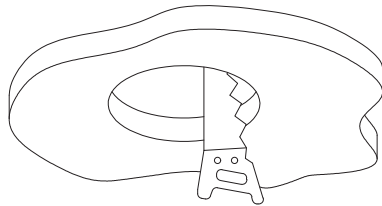

Cut-Out
 $\text{Ø}43\text{-}44\text{mm}$

Installation Instruction

3

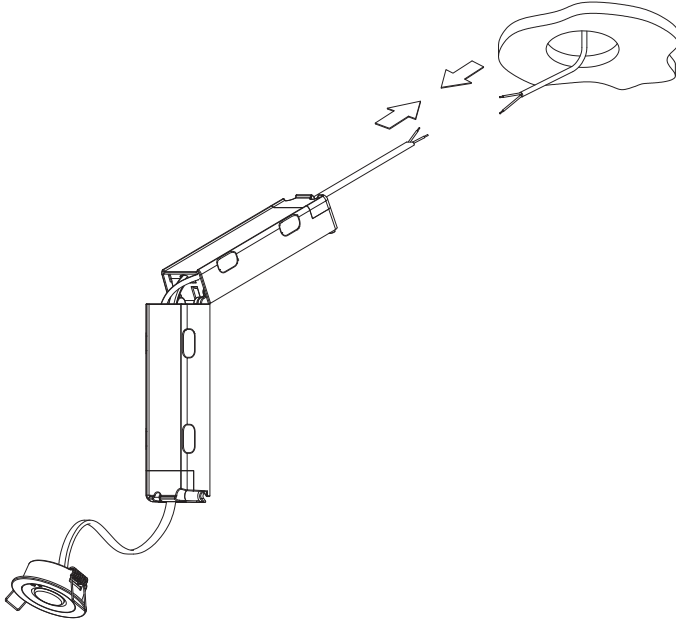

4

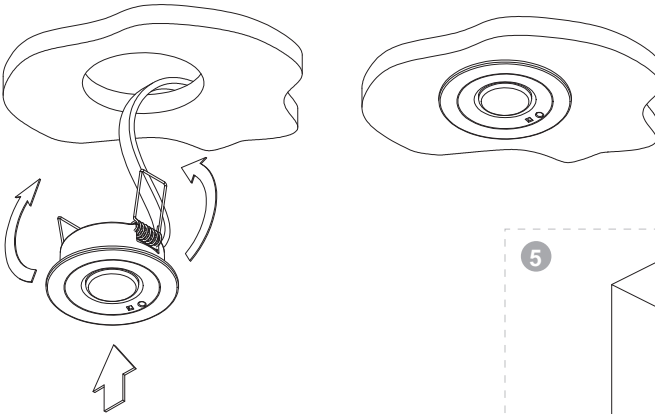

5

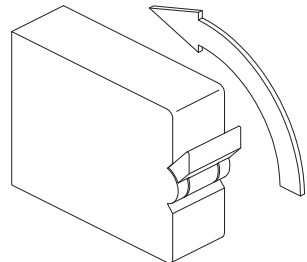

Lens Replacement

1

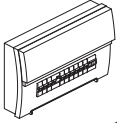

ALWAYS SWITCH OFF THE
MAINS SUPPLY BEFORE
INSTALLATION OR SERVICING

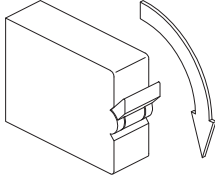

2

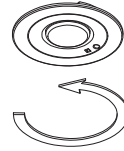
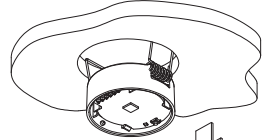
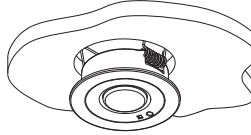

3

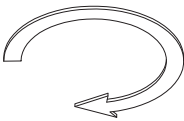
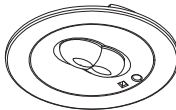
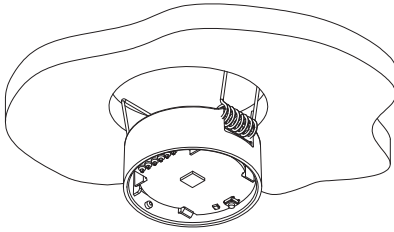

4

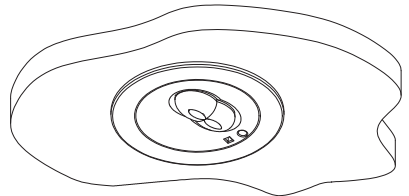

5

